

Framing Information: 31H (75x65H) Indoor-Outdoor Tunnel

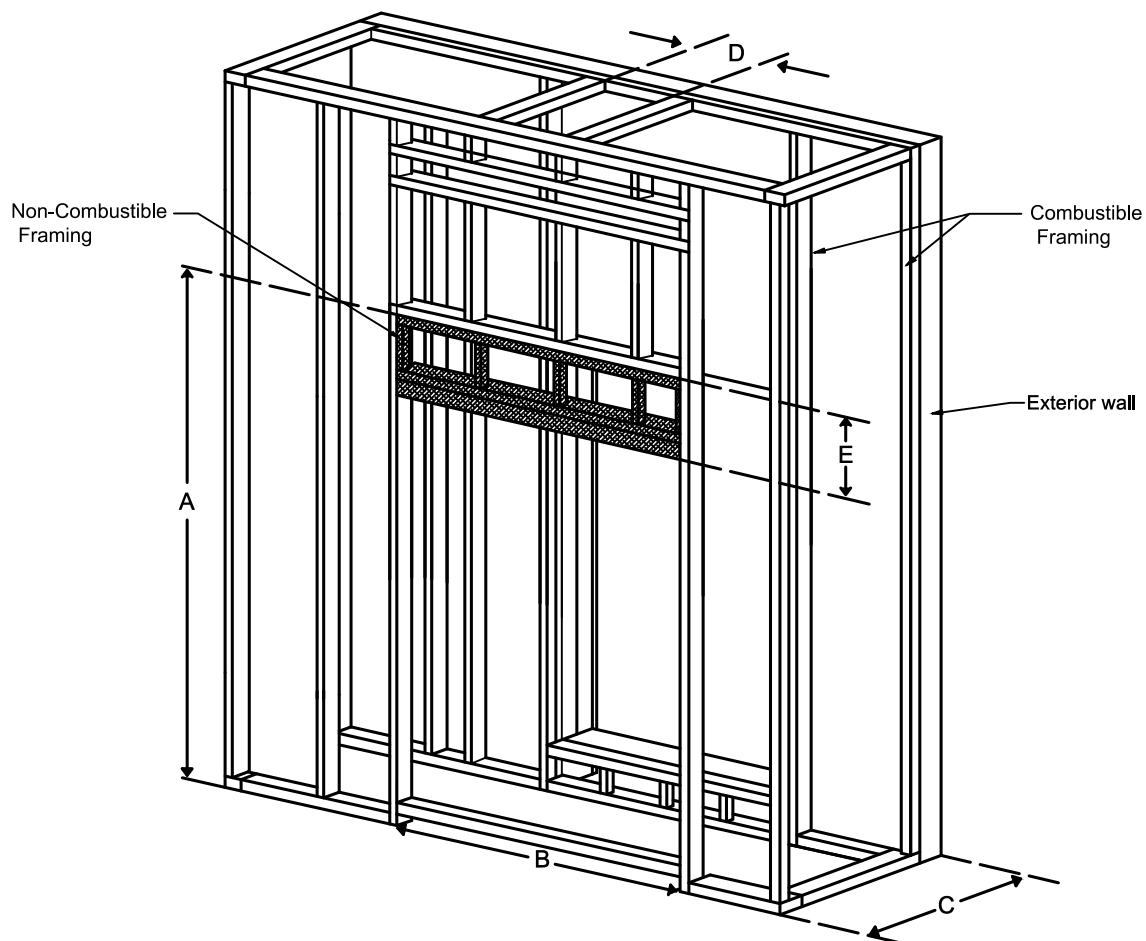

Framing Dimensions



Model	A	B	C		D	E
			MIN	MAX		
31H In-Out	92 ⁹ / ₁₆ "	40 ¹ / ₈ "	24 ⁵ / ₈ "	27 ¹ / ₄ "	Refer to Vent Manufacturer's Firestop Dimensions	13 ³ / ₄ "

Note :

1. Drawings are not to Scale
2. All dimensions in inches
3. No weight can be transferred to the fireplace. ALL FRAMING MUST BE SELF-SUPPORTED.

Framing Information: 31H (75x65H) Indoor-Outdoor Tunnel



Framing Details

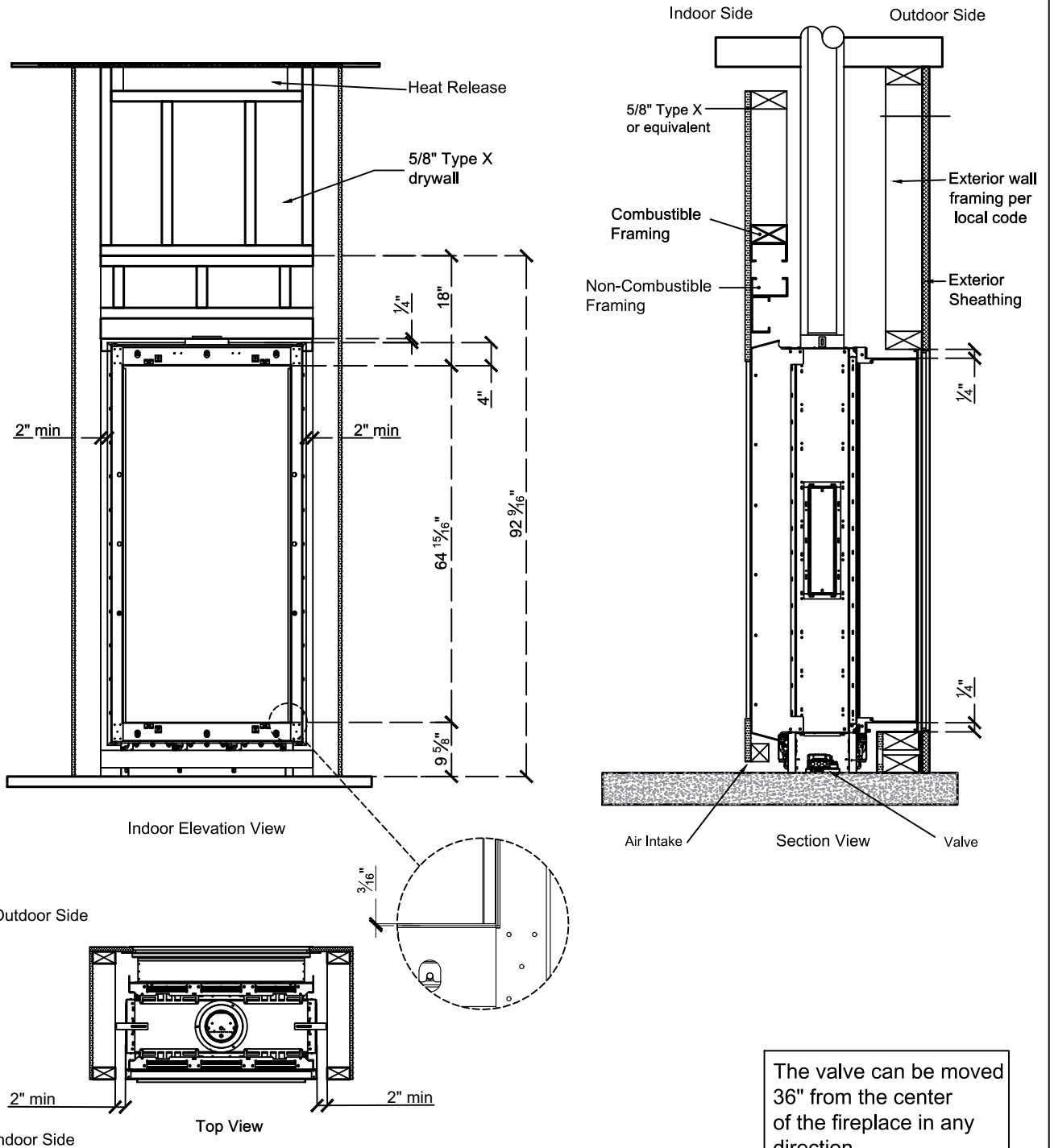

The valve can be moved 36" from the center of the fireplace in any direction

- Note :
1. Drawings are not to Scale
 2. All dimensions in inches
 3. No weight can be transferred to the fireplace. ALL FRAMING MUST BE SELF-SUPPORTED.

Framing Information: 31H (75x65H) Indoor-Outdoor Tunnel



Exterior Framing Details

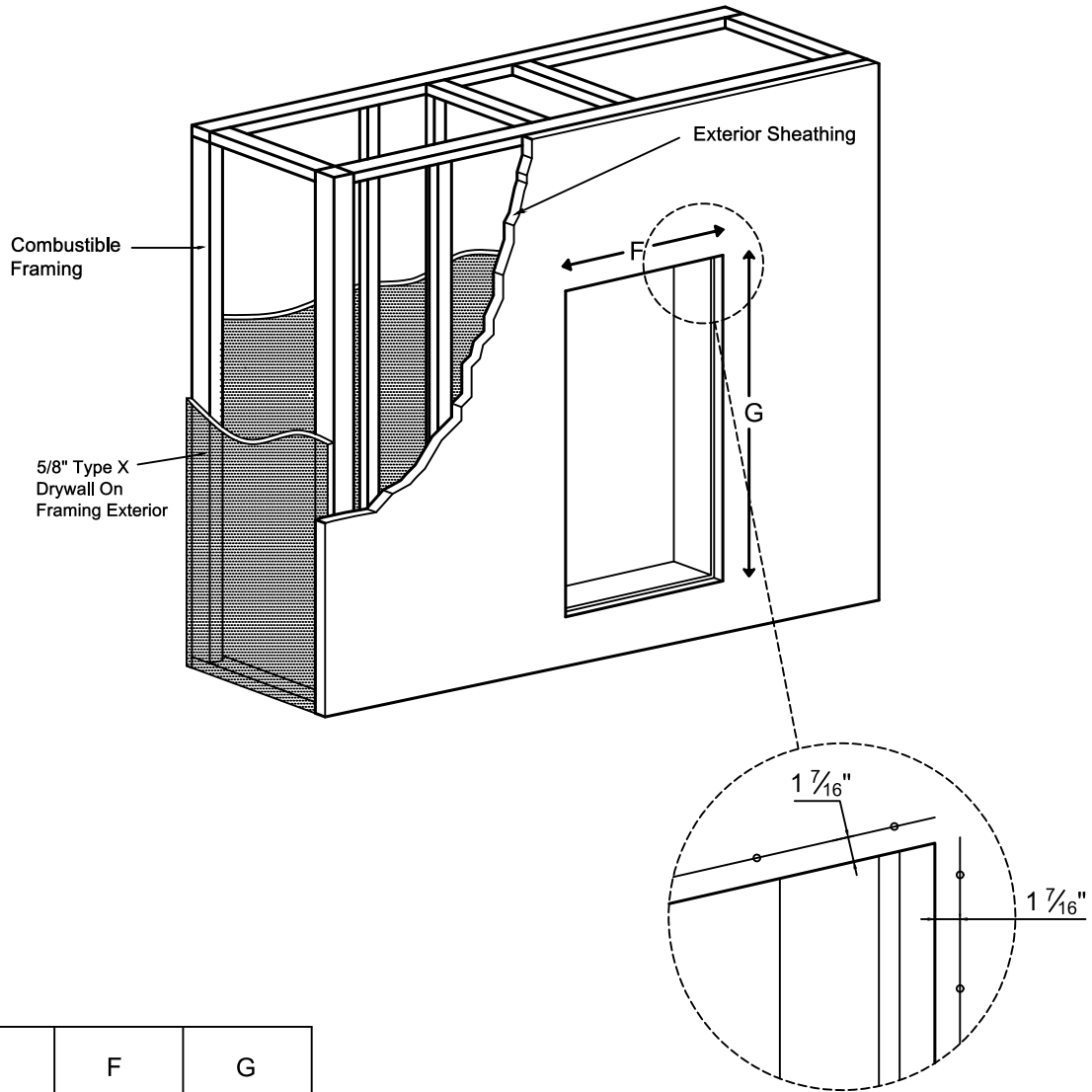

Model	F	G
31H In-Out	32 1/4"	69 3/8"

Note : 1. Drawings are not to Scale
 2. All dimensions in inches

Framing Information: 31H (75x65H) Indoor-Outdoor Tunnel



Fireplace Dimensions

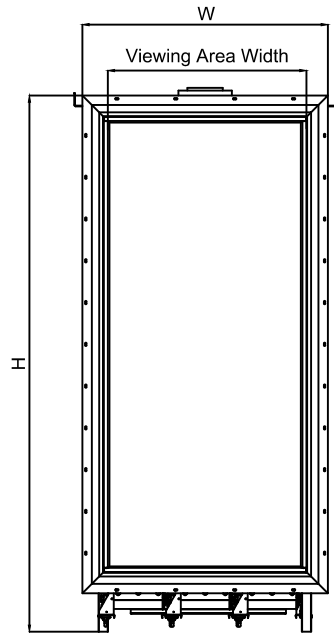

Outdoor Front View

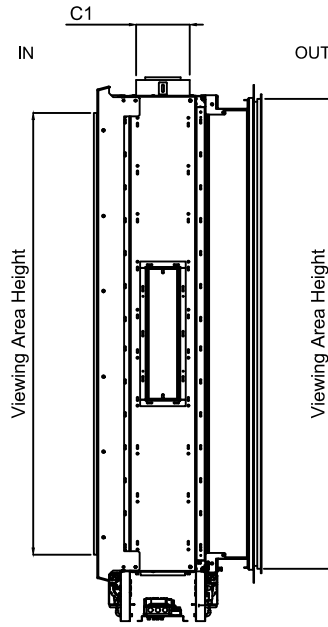

Side View

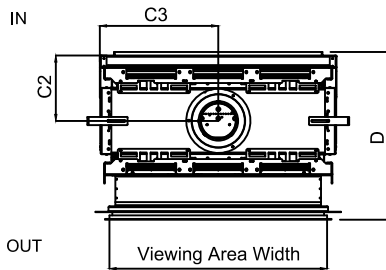

Top View

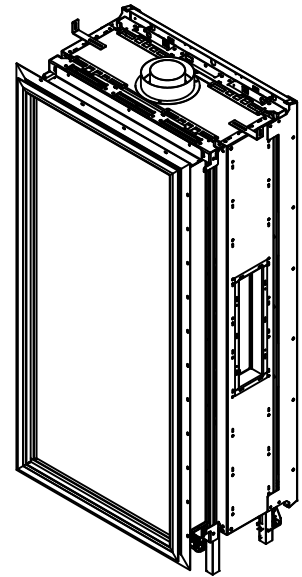

Model	(H) Height	(W) Width	(D) fixed Depth	C1	C2	C3	Viewing Area	
							IN	OUT
31H In-Out	78 5/8"	36 1/8"	24 1/16"	7 7/8"	9 9/16"	18 1/16"	30 5/8" W X 64 15/16" H	32" W X 69 1/8" H

Note : 1. Drawings are not to Scale
2. All dimensions in inches

Framing Information: 31H (75x65H) Indoor-Outdoor Tunnel



Fireplace Dimensions

Minimum depth

Maximum depth

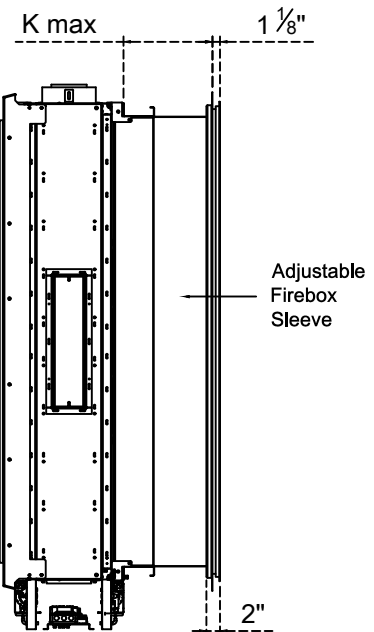
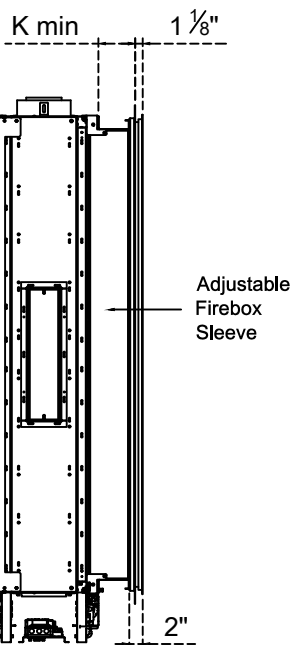
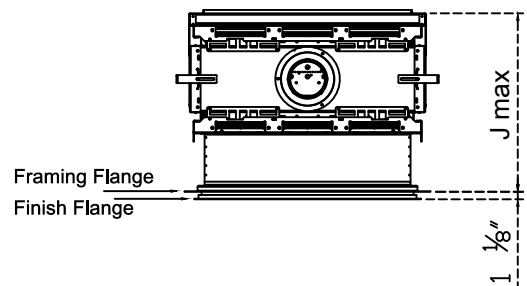
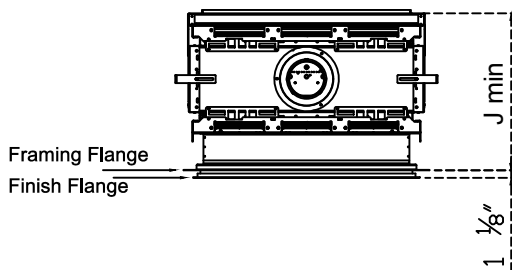

Model	J min	J max	K min	K max
31H In-Out	23 1/2"	26 1/8"	5 3/8"	8 1/16"

Note : 1. Drawings are not to Scale
2. All dimensions in inches