

# FRAMING INFORMATION: E-LECTRA 60"

ORTAL®

## FRAMING DIMENSIONS

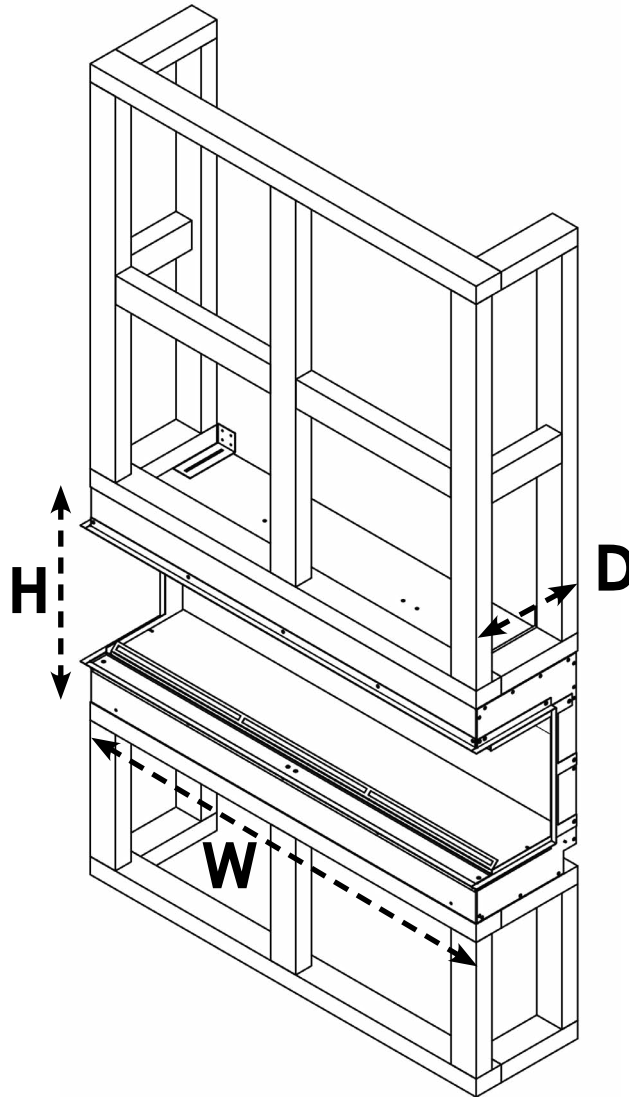

### FRAMING

Fireplace	A. Height	B. Width	C. Depth
E-lectra 60	23 <sup>7</sup> / <sub>64</sub> "	60 <sup>7</sup> / <sub>16</sub> "	11 <sup>3</sup> / <sub>8</sub> "

- Note:**
1. Drawings are not to scale
  2. All dimensions in inches
  3. No weight can be transferred to the fireplace.

**ALL FRAMING MUST BE SELF-SUPPORTED**